



CEBEF.



1919 - 2014

VII. Fabrication sur mesure Maatwerk

Fabrications spéciales/ Maatwerk



Pince palplanche – dekplatenklem 45t



Crochets tuyaux – buizenhaken – 50t



Pince tôle - plaatklem

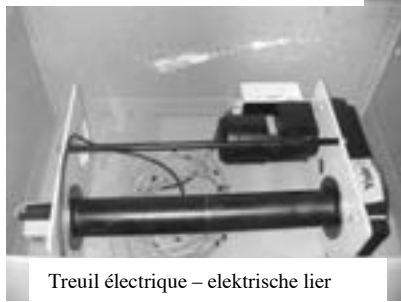

Treuil électrique – elektrische lier



Crochet spécial d'arrimage – speciale sjerhaak



Moufle pour grue – kabelblok 50 t



Potence sur colonne – kolomzwenkraan
Potence murale- muurzwenkraan



Crochets spéciales – speciale haken 23t



Palonnier big bag (sur fourches) -
Hijsjuk big bags voor op de vorken van
heftruck



Nacelle pour grue - veiligheidskooi

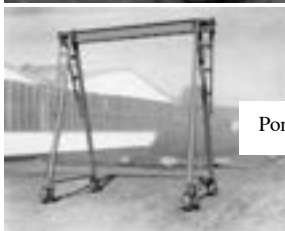

Portique - portaalkraan



Chaîne d'ancrage - ankerketting

Palonniers – hijsjukken

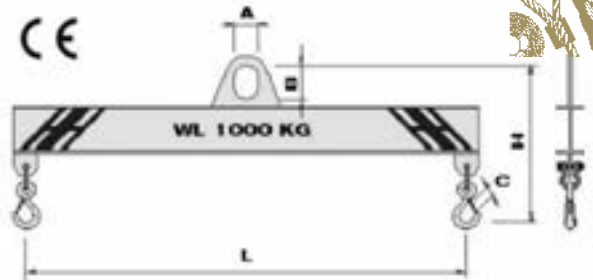
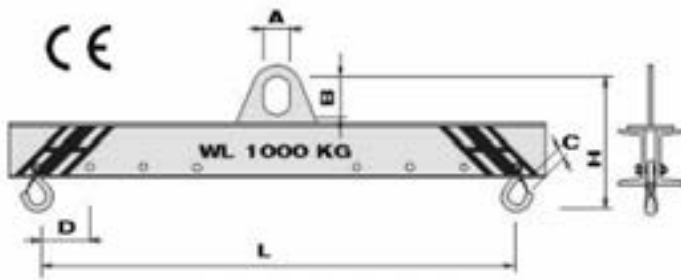

Réglables – fixes – regelbaar - vast

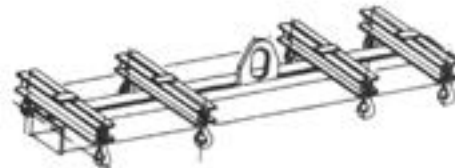
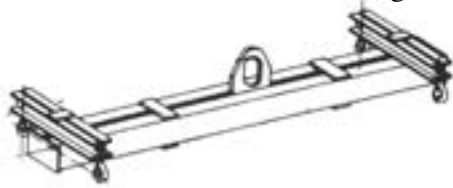

Traverse pour/voor BIG-BAGS



- Palonnier en forme de croix avec crochets à linguets aux extrémités.

- Hijsjuk in kruisvorm voorzien van haken met klep.



Traverse pour fourches simple et double
– heftrucktraversen enkel en dubbel

Potence sur colonne – murale - portique Kolom – en muurzwenkkranen - portalen

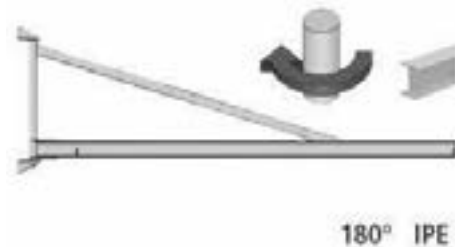
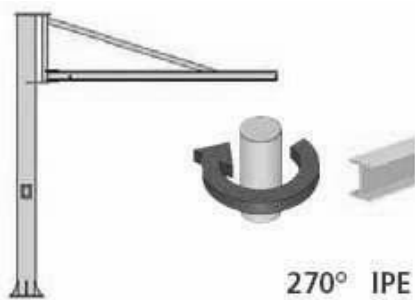



La solution pour le placement de vos colonnes en béton

De oplossing voor het plaatsen van betonkolom

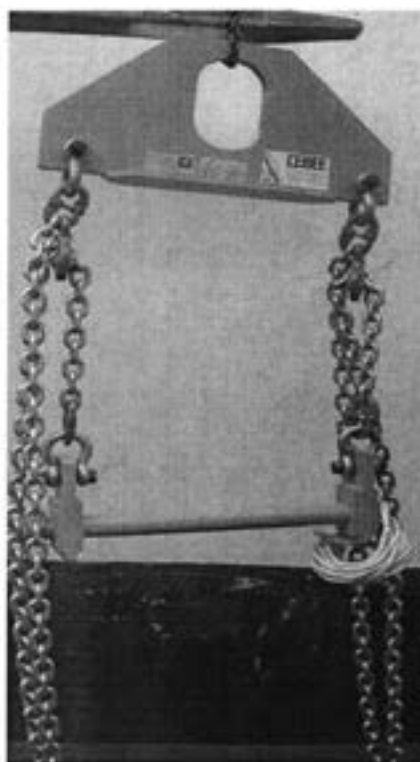

Palonnier, décrochage à distance, fabrication sur mesure, charges & dimensions pour colonnes carrées, rondes ou rectangulaires

Hijsjuk, afhaken vanop afstand, fabricatie op maat, werklust en afmetingen, voor vierkante, ronde of rechthoekige balken

CE et agréé par un organisme officiel suivant art. 280 du RGPT

CE en gekeurd door een erkend organisme volgens art. 280 van ARAB

